

# Sample Boards 2008

---

LAST UPDATED: 06-01-2022

---

DEMO



# Sample Boards

- 08-001 Burst Trigger .....3
- 08-002 Flatcable connectors .....4
- 08-006 JFet IV converter module M1s .....5
- 08-007 PSD Detector .....6
- 08-008-1 Sample Boards Steele .....7
- 08-008-2 Sample Boards Steele .....8
- 08-008-3 Sample Boards Steele .....9
- 08-008-4 Sample Boards Steele .....10
- 08-008-5 Sample Boards Steele .....11
- 08-008-6 Sample Boards Steele .....12
- 08-008-7 Sample Boards Steele .....13
- 08-008-8 Sample Boards Steele .....14

# 08-001 Burst Trigger

Interface

size (LxWxT):

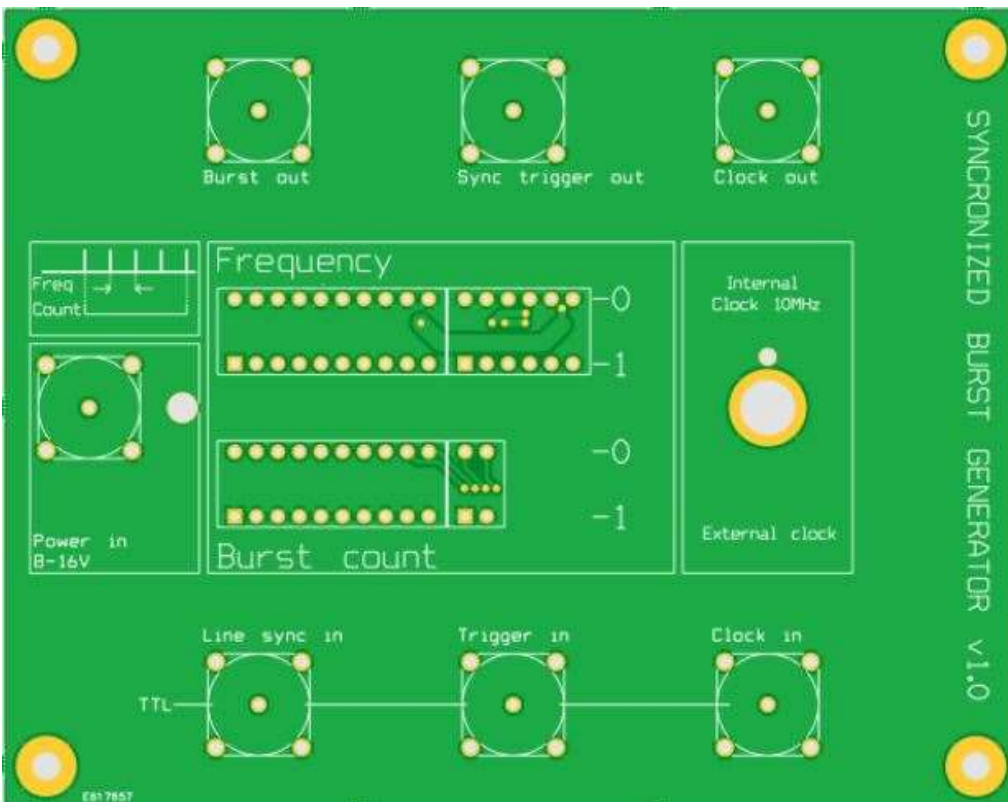
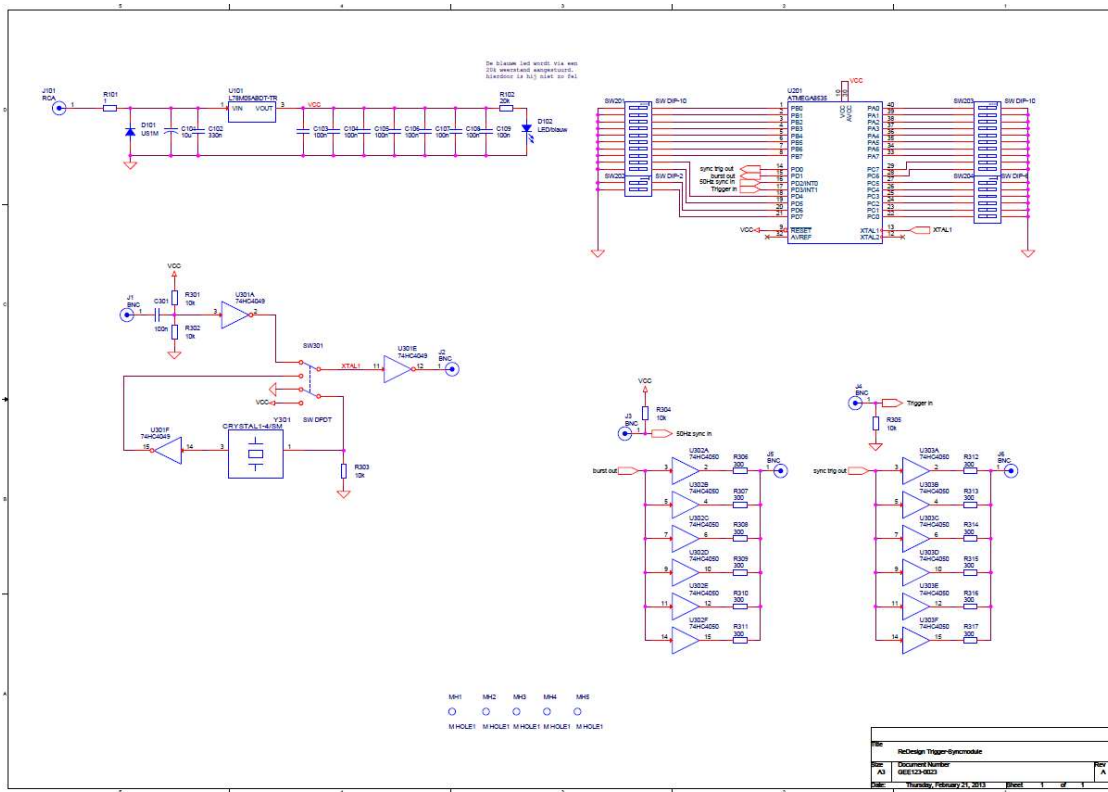

# 08-002 Flatcable connectors

Adapter board

size (LxWxT):

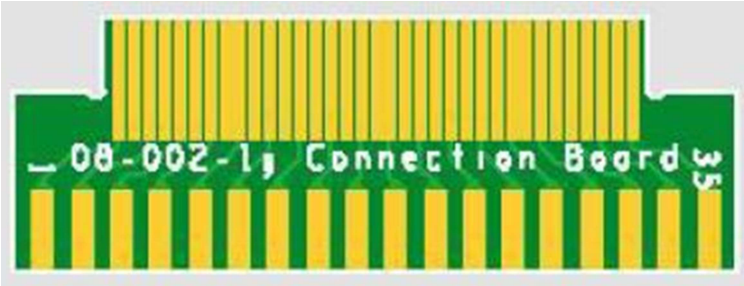

 Delft University of Technology		
DEMO-CEO Van der Waalsweg 8 2628 CH Delft		
Title Flatcable connectors		
Size	Document Number	Rev
A4	08-002-2	1.0

# 08-006 JFet IV converter module M1s

Multiplexer  
size (LxWxT):

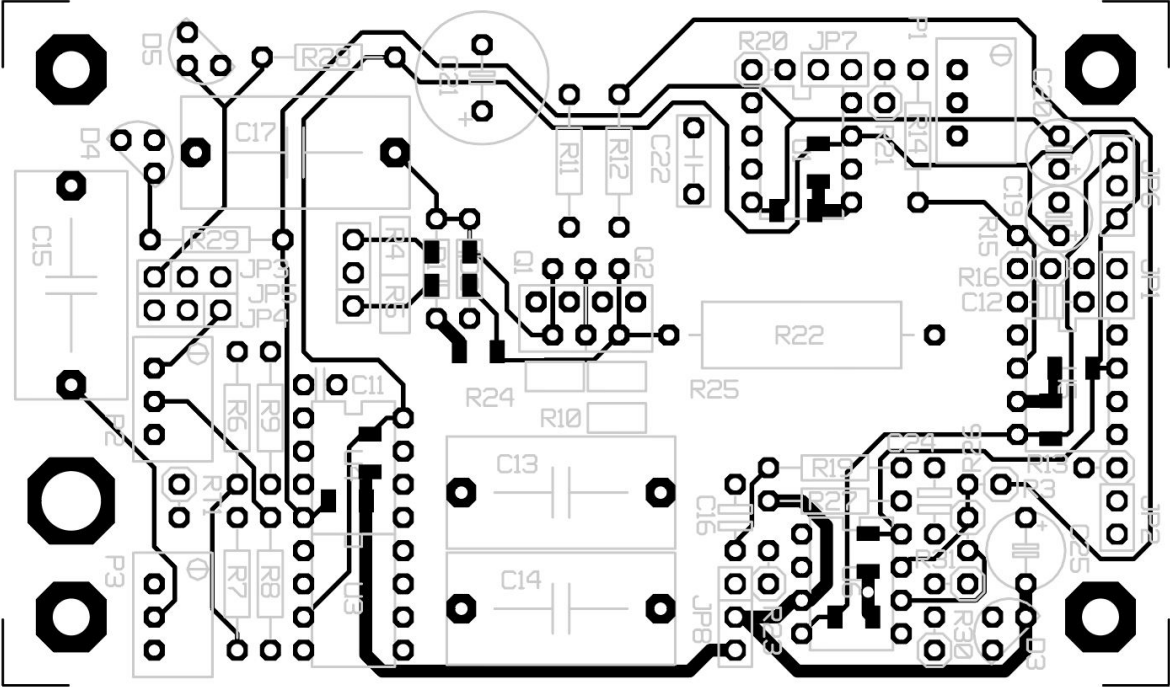

# 08-007 PSD Detector

Sample Board

size (LxWxT):

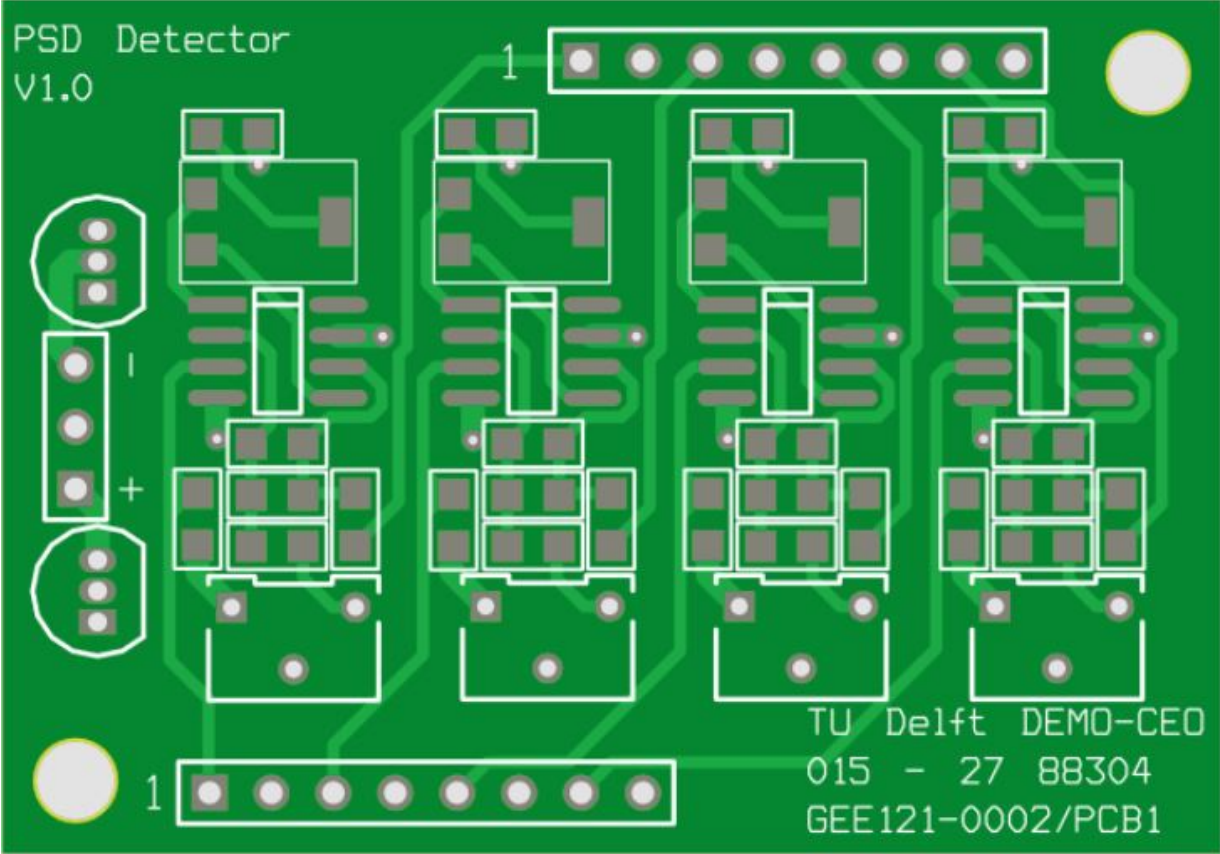

# 08-008-1 Sample Boards Steele

Sample Board  
size (LxWxT):

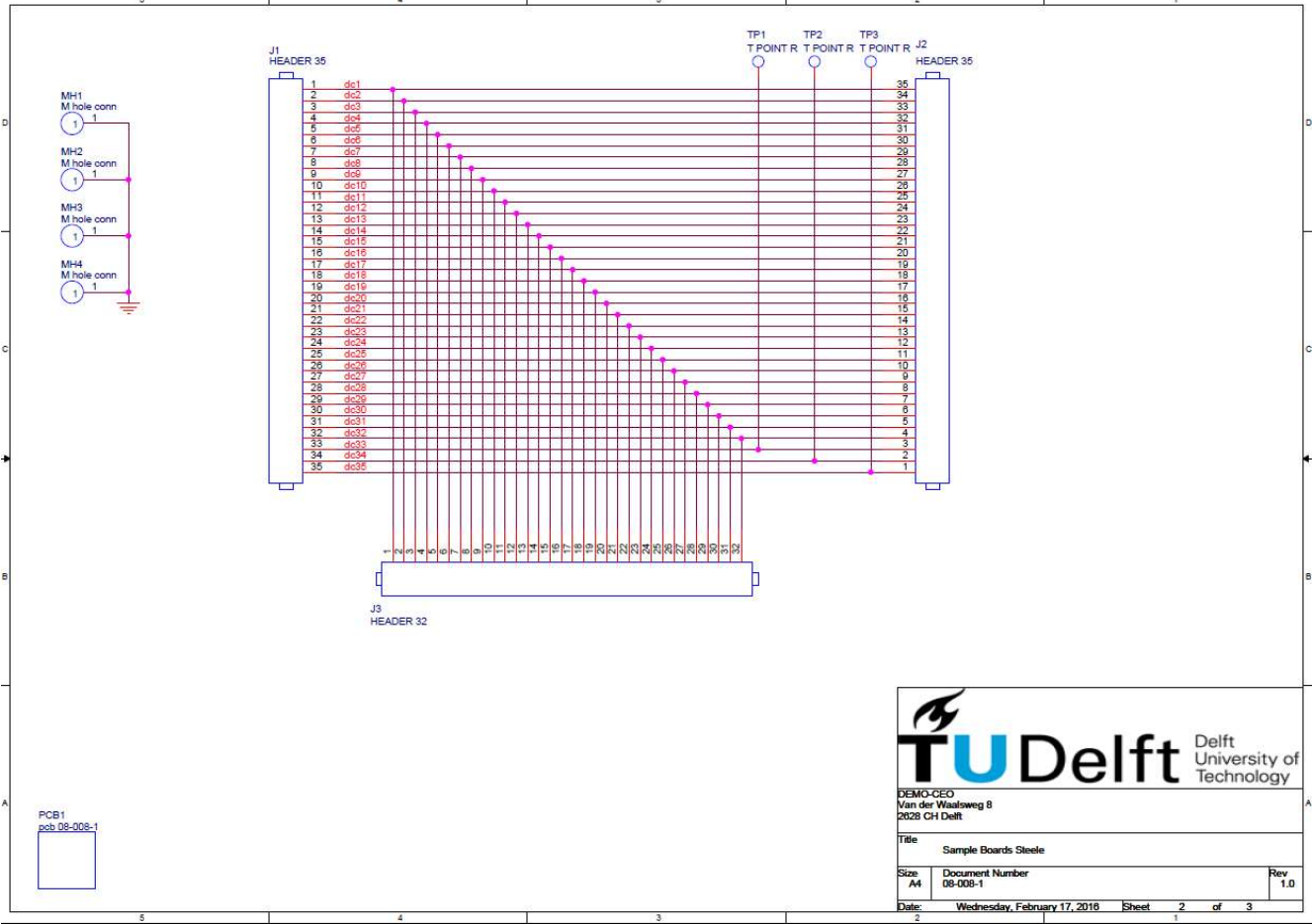

# 08-008-2 Sample Boards Steele

Sample Board  
size (LxWxT):

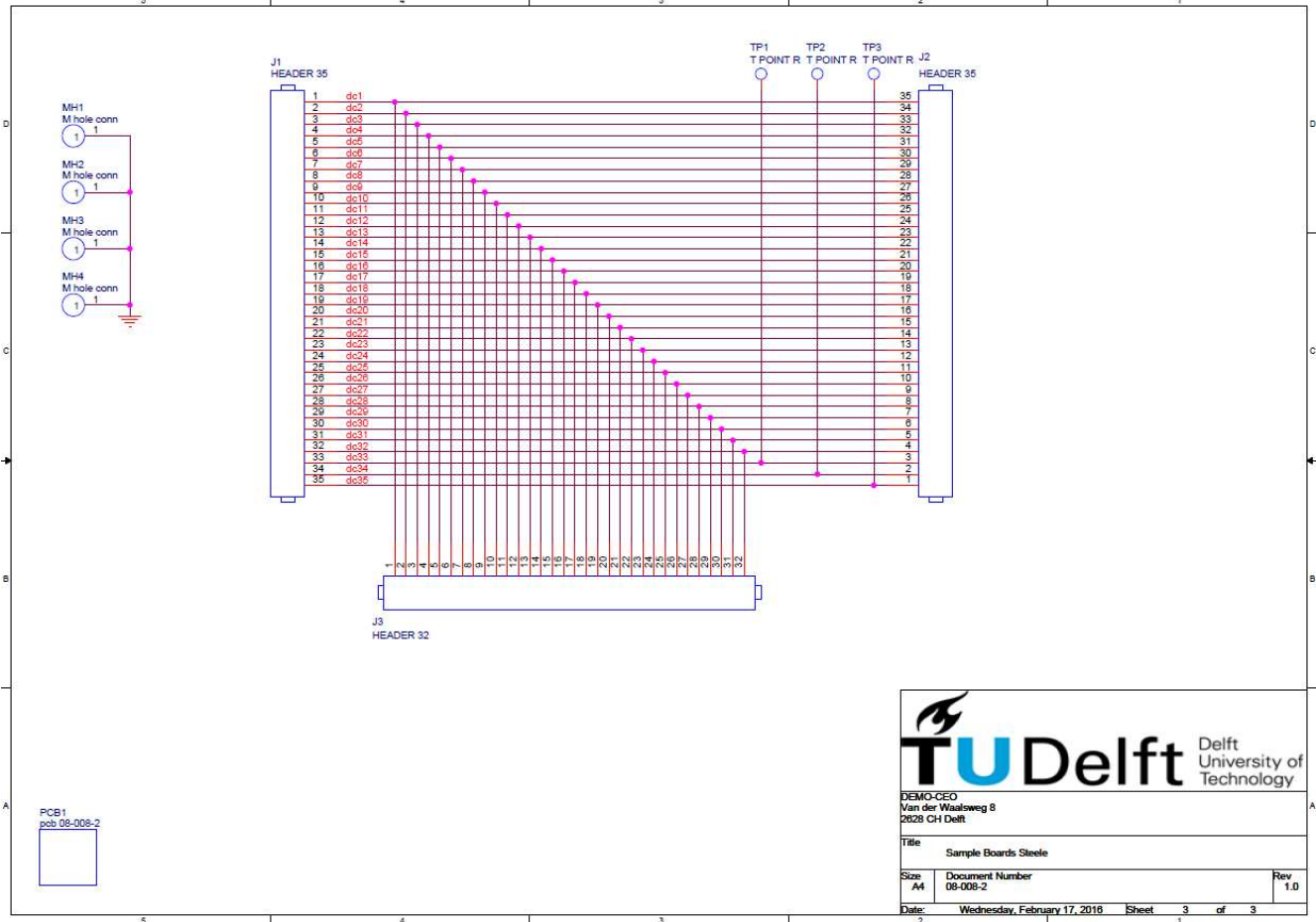



# 08-008-3 Sample Boards Steele

Sample Board  
size (LxWxT):

5 4 3 2 1

D

C

B

A

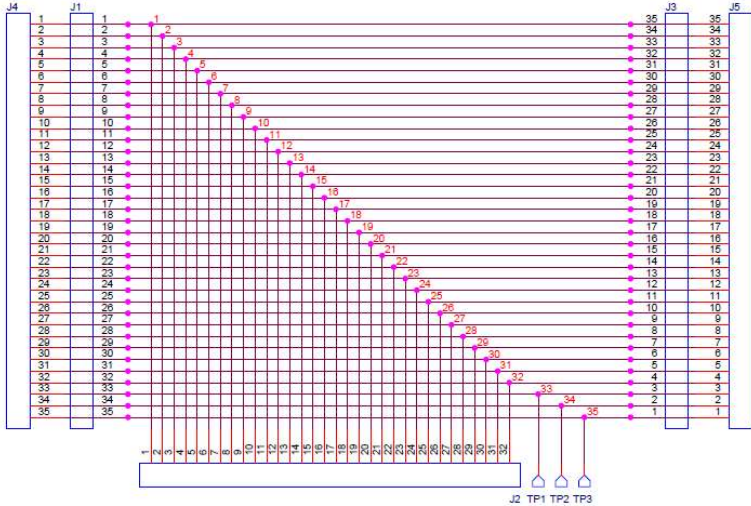

 <b>TU Delft</b> Delft University of Technology	
DEMO-CEO Van der Waalweg 8 2626 CH Delft	
Title Sample Boards Steele	
Size A4	Document Number 08-008-3
Date: Wednesday, February 17, 2016	
Sheet 1 of 3	
Rev 1.0	

# 08-008-4 Sample Boards Steele

Sample Board  
size (LxWxT):

5 4 3 2 1

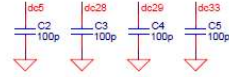
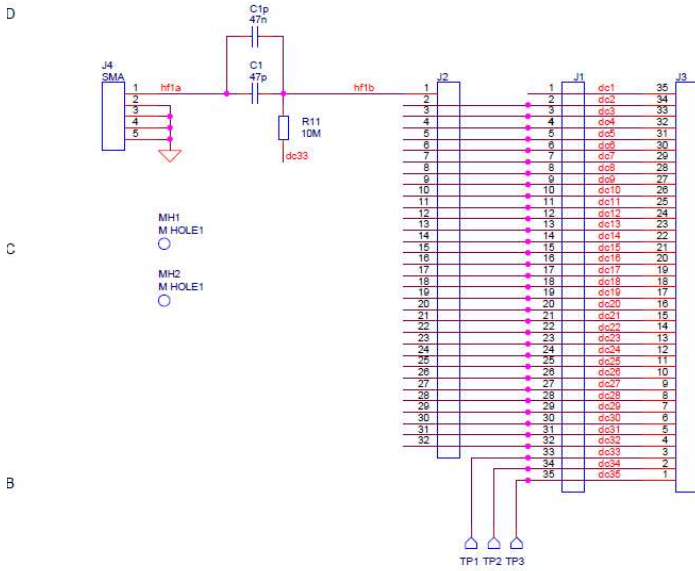

**TU Delft** Delft University of Technology

DEMO-CEO  
Van der Waalweg 8  
2628 CH Delft

Title: Sample Boards Steele

Size: A4	Document Number: 08-008-4	Rev: 1.0
----------	---------------------------	----------

Date: Tuesday, March 01, 2016 [Sheet 1 of 4

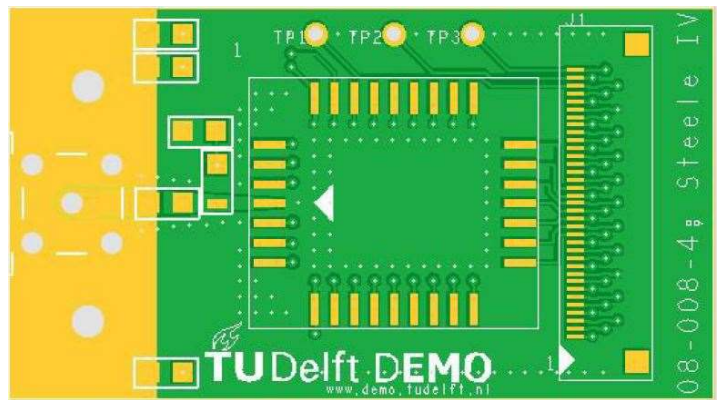
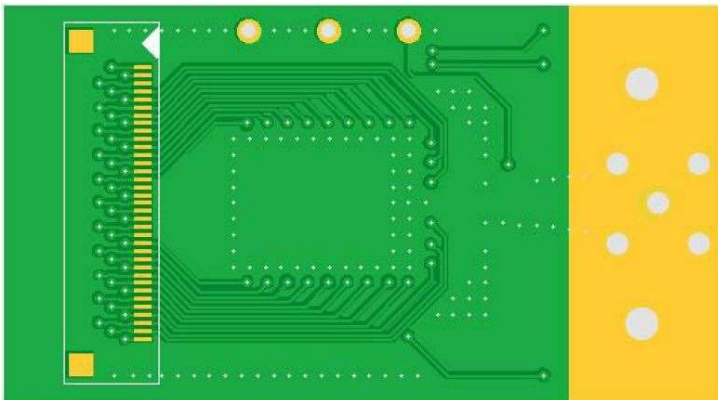

# 08-008-5 Sample Boards Steele

Sample Board  
size (LxWxT):

5

4

3

2

1

D

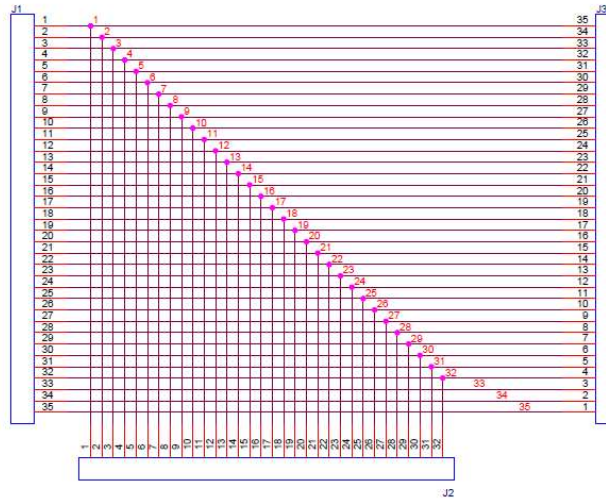

C

B

MH1    MH2  
      
 M HOLE1 M HOLE1

A



**TU Delft** Delft University of Technology

DEMO-CEO  
 Van der Waalweg 8  
 2628 CH Delft

Title: Sample Boards Steele

Size: A4	Document Number: 08-008-5	Rev: 1.0
Date: Tuesday, March 01, 2016		Sheet: 1 of 5

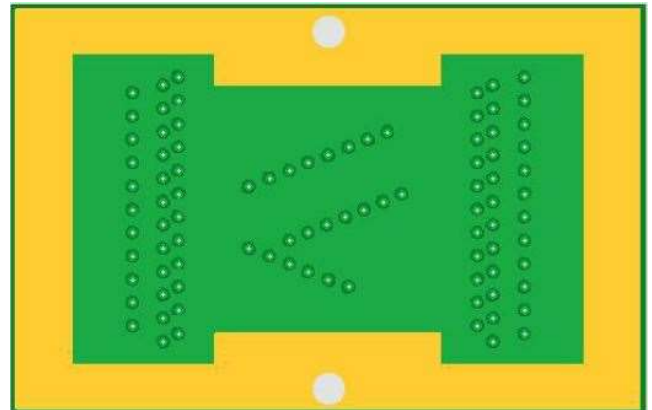
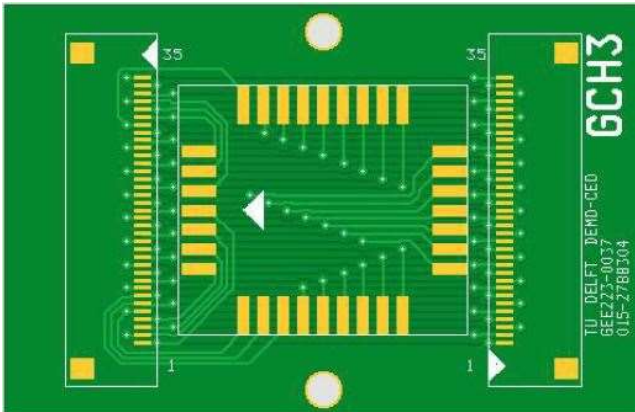

# 08-008-6 Sample Boards Steele

Sample Board  
size (LxWxT):

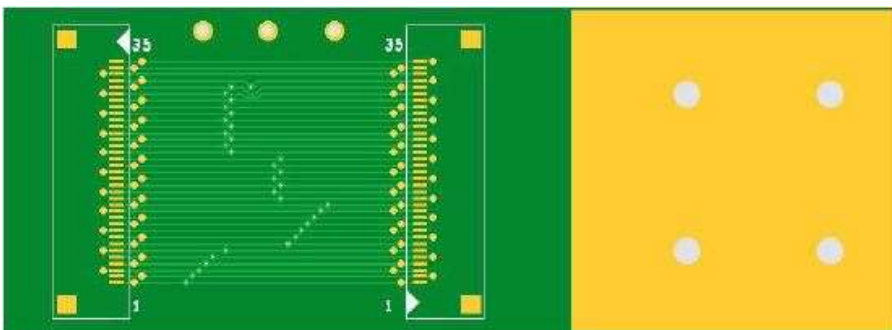
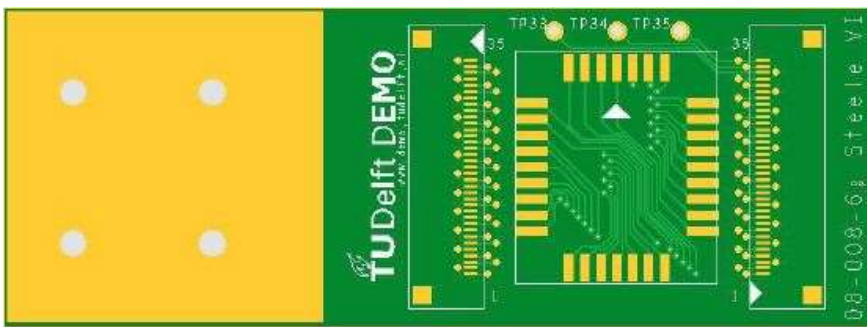
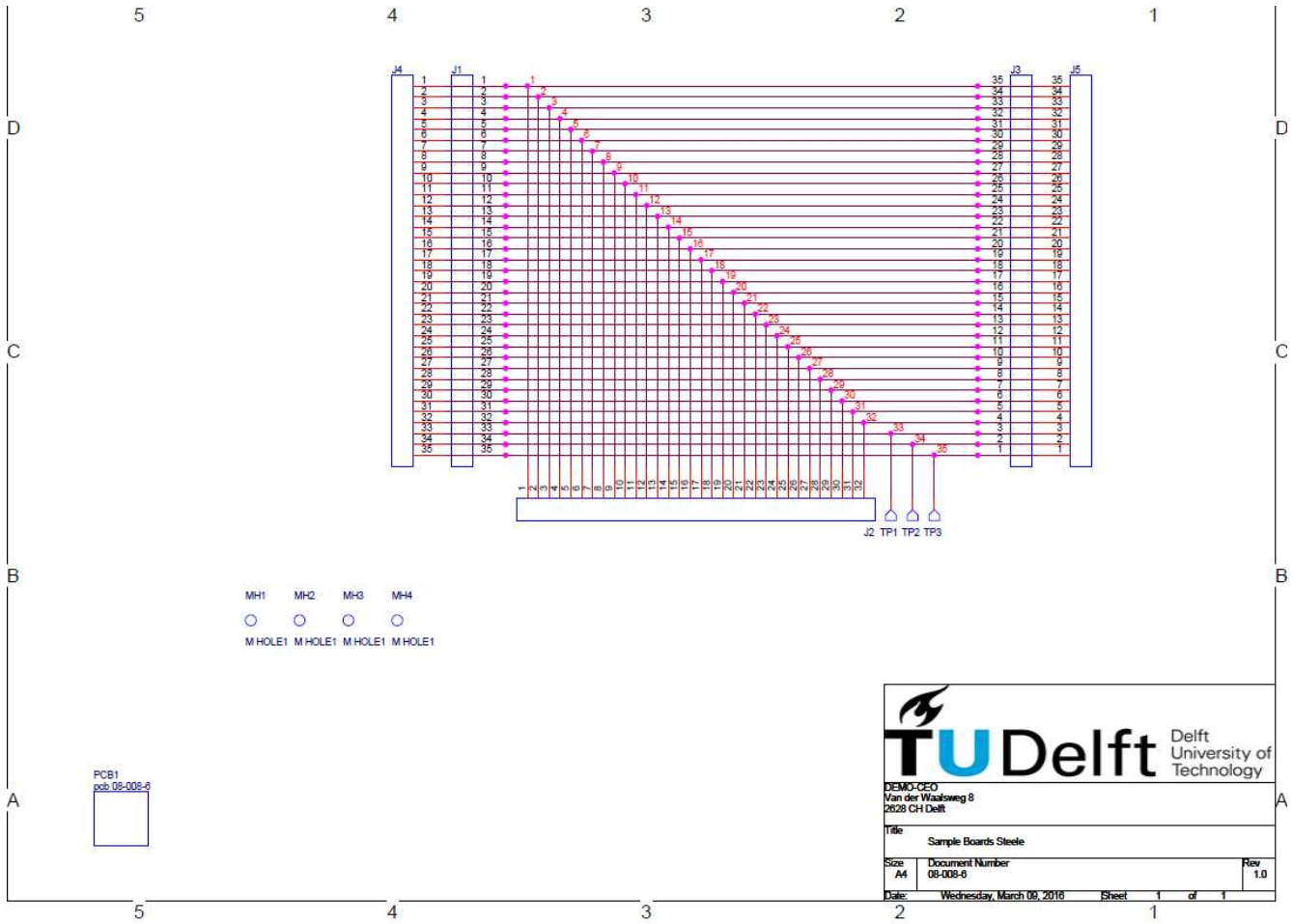

# 08-008-7 Sample Boards Steele

Sample Board  
size (LxWxT):

5 4 3 2 1

D

C

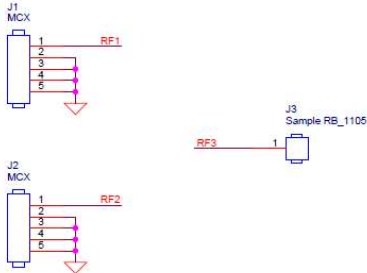

B



**TU Delft** Delft University of Technology

DEMO-CEO  
Van der Waalweg 8  
2628 CH Delft

---

Title: Sample Boards Steele

---

Size: A4	Document Number: 08-008-7	Rev: 1.0
----------	---------------------------	----------

Date: Friday, March 11, 2016 [Sheet 1 of 1]



# 08-008-8 Sample Boards Steele

Sample Board  
size (LxWxT):

5 4 3 2 1

D

C

B

A

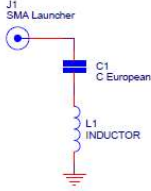

PCB1  
pcb 08-008-8



		Delft University of Technology
DEMO-CEO Van der Waalweg 8 2026 CH Delft		
Title Sample Boards Steele		
Size A4	Document Number 08-008-8	Rev 1.0
Date: Wednesday, March 16, 2016 Sheet 1 of 1		